ECAM22X.6Y - 22X.8Y

MAGNIFICA START

BEAN TO CUP ESPRESSO AND
CAPPUCCINO MACHINE

Instructions for Use



DeLonghi

A

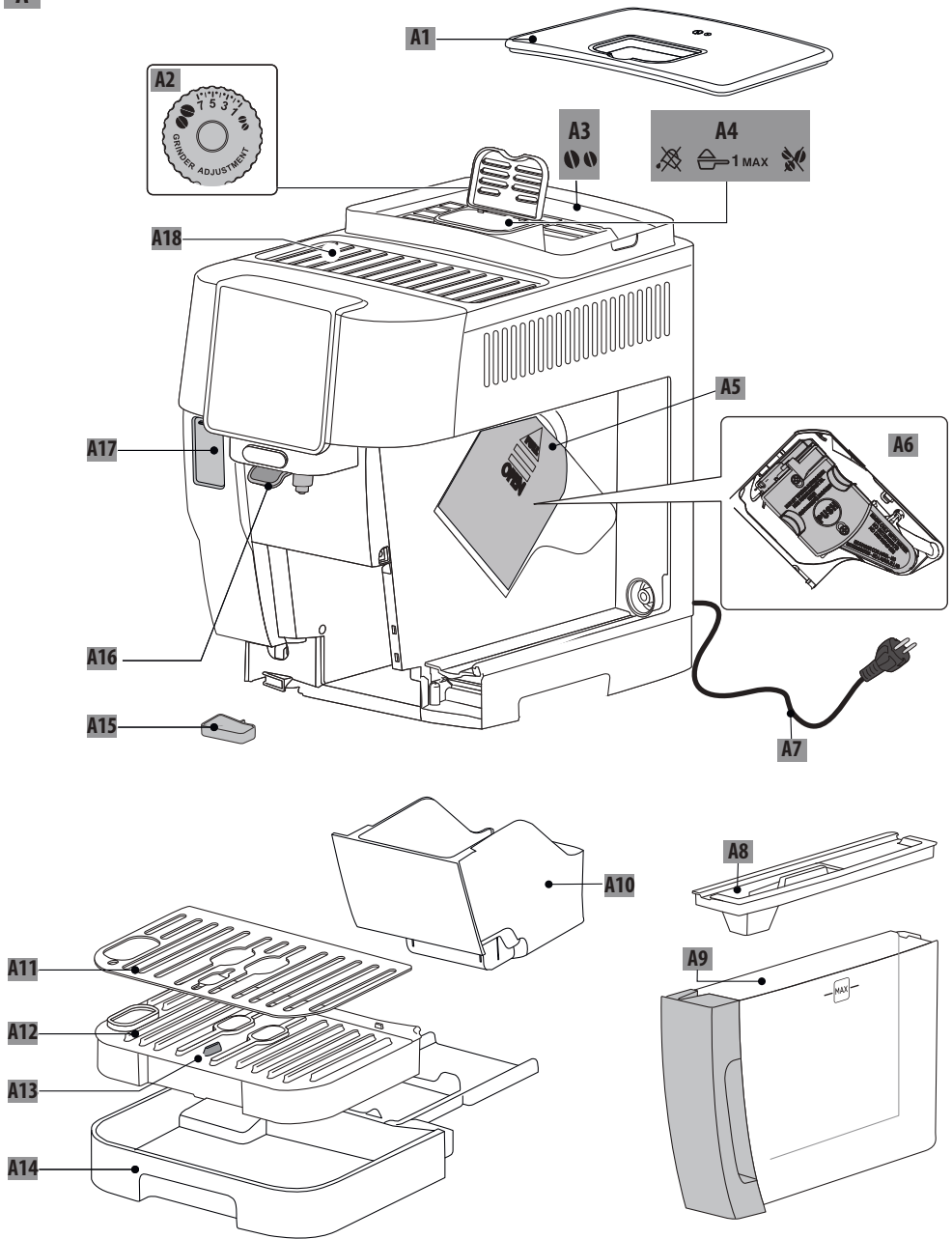

B-C

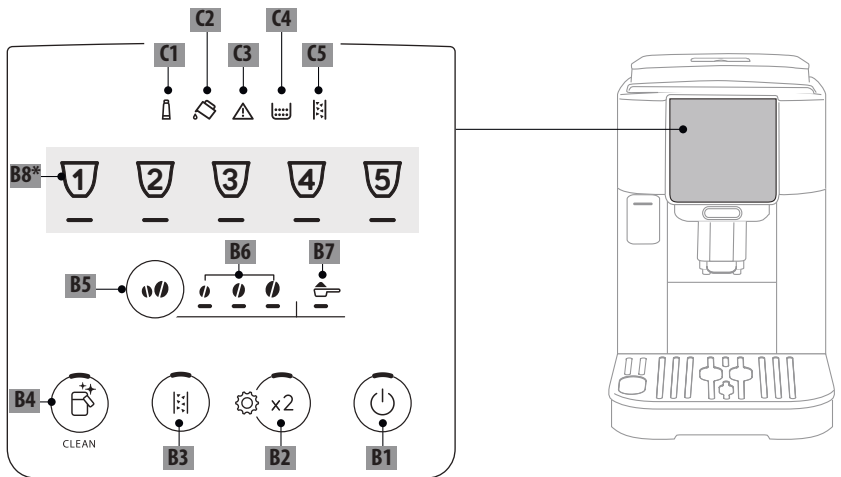

D*

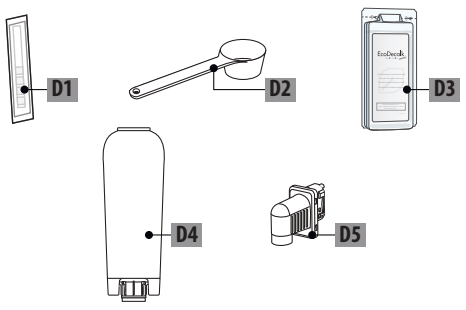

E

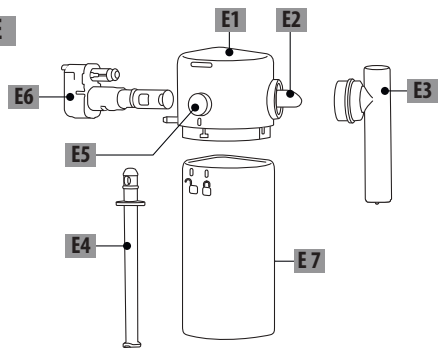

50°C	×	×	×	✓	✓
	✓	✓	✓	✓	✓

CONTENTS





1. INTRODUCTION	5
1.1 Letters in brackets.....	5
1.2 Troubleshooting and repairs.....	5
2. DESCRIPTION	5
2.1 Description of the appliance - A	5
2.2 Description of control panel - B	5
2.3 Description of indicator lights - C	5
2.4 Description of accessories - D*	5
2.5 Description of milk carafe - E.....	5
3. SETTING UP THE APPLIANCE	6
4. WATER SOFTENER FILTER	6
4.1 Replacing the filter.....	7
4.2 Removing the filter	7
5. MEASURING WATER HARDNESS	7
6. TURNING THE MACHINE ON	8
7. TURNING THE MACHINE OFF	8
7.1 Switching off for extended periods:	8
8. MAKING COFFEE DRINKS	8
8.1 Making coffee using coffee beans	8
8.2 Making 2 cups of coffee	9
8.3 Making coffee using pre-ground coffee ..	9
8.4 General indications for making coffee-based drinks	9
8.5 Varying the intensity of the coffee	9
8.6 Rinsing	10
8.7 Tips for a hotter coffee.....	10
8.8 Adjusting the coffee mill	10
8.9 Customizing the quantity in the cup	10
9. MAKING MILK-BASED DRINKS	10
9.1 What milk to use?	10
9.2 How much milk?	11
9.3 Filling and attaching the milk carafe	11
9.4 Selection of coffee intensity or use of pre-ground coffee.....	11
9.5 Delivering milk-based drinks.....	12
9.6 Cleaning the milk carafe after each use.	12
9.7 Customizing the quantity in the cup	12
10. DELIVERING HOT WATER	13
10.1 Customizing the quantity of hot water..	13
11. TIPS FOR ENERGY SAVING	13
12. SETTINGS MENU	13
12.1 Restore factory settings.....	16
14. THOROUGH CLEANING OF MILK CARAFE ..	18
15. CLEANING THE INFUSER	19
16. DESCALING	19
17. EXPLANATION OF LIGHTS	21
18. TROUBLESHOOTING	23
19. TECHNICAL DATA	25

Before using the appliance for the first time, be sure to read the safety warnings.

1. INTRODUCTION

Take a few minutes to read these Instructions for Use. This will avoid all risks and damage to the appliance.

The Leds and indicator lights on the panel will help in ensuring correct interaction with the machine:

	Off	--
	Permanently alight	Function available
	Blinking	Function in progress
	Blinking rapidly	User action required

The same symbols are also used in the Quick Guide provided with the product.

1.1 Letters in brackets

The letters in brackets refer to the description of the appliance on pages 2- 3.

1.2 Troubleshooting and repairs

In the event of problems, first try and resolve them by reading the information given in sections "17. Explanation of lights" and "18. Troubleshooting".

If this does not resolve the problem or further information is required, consult the customer services department at the numbers indicated on the website www.delonghi.com.

If repairs are required, contact De'Longhi customer services only. Addresses can be found on the website www.delonghi.com.

2. DESCRIPTION

2.1 Description of the appliance - A

- A1. Beans container lid
- A2. Coffee mill adjustment dial
- A3. Beans container
- A4. Pre-ground coffee funnel
- A5. Infuser flap
- A6. Removable infuser
- A7. Power cord
- A8. Water tank lid
- A9. Water tank

- A10. Coffee grounds container
- A11. Cup tray
- A12. Drip tray grille
- A13. Drip tray water level indicator
- A14. Drip tray
- A15. Condensate tray
- A16. Height-adjustable coffee spouts
- A17. Accessories connector access flap
- A18. Cup shelf

2.2 Description of control panel - B

- B1. ON/standby button with built-in Led
- B2. X2 button with built-in Led (if pressed and held for 5 seconds, accesses the settings menu)
- B3. Descalc cycle selection button
- B4. Clean button (milk carafe) with built-in Led (if pressed and held for 5 seconds, activates manual rinse)
- B5. Intensity or pre-ground selection button
- B6. Intensity selection Led
- B7. Pre-ground selection Led
- B8. Drink selection button (*number and type of drinks differ according to models)

2.3 Description of indicator lights - C

- C1. Filter exhausted:
Indicator permanently alight: filter must be replaced
Indicator blinking: filter installation in progress
- C2. No water:
Indicator permanently alight: insufficient water in the tank (A9)
Indicator blinking: tank not in position
- C3. General alarm indicator
- C4. Grounds container indicator:
Indicator permanently alight: grounds container (A10) needs emptying
Indicator blinking: grounds container not in position
- C5. Descalc indicator:
Indicator permanently alight: machine needs descaling
Indicator blinking: descaling in progress

2.4 Description of accessories - D*

(*number and type differ according to model)

- D1. "Total Hardness Test" strip
- D2. Pre-ground coffee measure
- D3. Descaler
- D4. Water softener filter
- D5. Hot water spout

2.5 Description of milk carafe - E

- E1. Lid with milk frother
- E2. Milk spout connector (non removable)
- E3. Frothed milk spout

- E4. Milk intake tube
- E5. Remove carafe/remove carafe connector button
- E6. Milk carafe connector
- E7. Milk container

3. SETTING UP THE APPLIANCE

Please note:

- When using the machine for the first time, all removable accessories making contact with water or milk should be rinsed with hot water. It is advisable to wash the milk carafe (E) (see section "14. Thorough cleaning of milk carafe").
- Any traces of coffee that may be found in the mill are left by the factory tests carried out on the machine before it goes on sale — evidence of the meticulous care we have for the product.
- The first time the machine is used, the water circuit will be empty and the appliance could be very noisy. The noise becomes less as the circuit fills.
- When starting the machine for the first time, make certain that the water spout (D5) is fitted.

1. Connect the appliance to the mains supply (fig. 1).

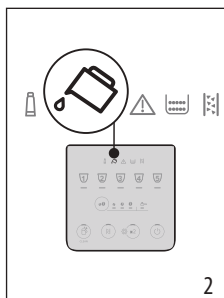
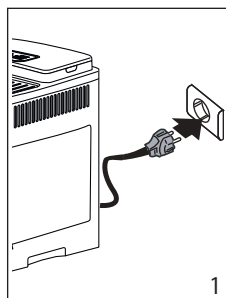

2. The indicator  (C2) will light up on the control panel (B) (fig. 2): remove the water tank (A9) (fig. 3), fill up to the MAX level with fresh drinking water (fig. 4), then reposition in the appliance.

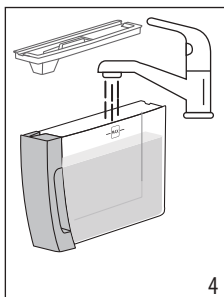
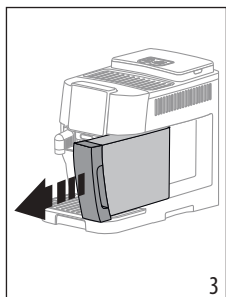

3. The Led  (B2) on the control panel will blink rapidly.
4. Position a container under the coffee spout (A16) and water spout (D5) (fig. 5).

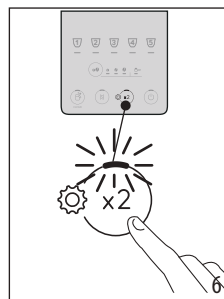
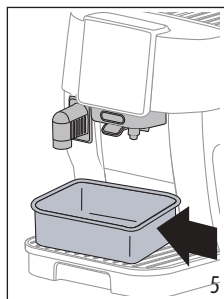

5. Press the  button (fig. 6): the internal water circuits start to fill and the appliance will release hot water from the water spout.
6. The flow will be interrupted, then after a few seconds, the machine releases water from the coffee spout.

When the flow of water stops completely, the machine is ready for use.

Please note:

- The first time the appliance is used, it will be necessary to make 4-5 cappuccinos before the drink in the cup tastes as it should.
- It is recommended that the water filter supplied be installed immediately. After two months (see date indicator), or after 3 weeks if the appliance has not been used, the filter should be replaced or removed even if the warning indicator (C1) is not alight.
- Select the appropriate water hardness setting as soon as possible (section "5. Measuring water hardness").

4. WATER SOFTENER FILTER

To ensure the performance of the machine remains constant over time, we recommend using a De'Longhi water softener filter.

For more information, visit the www.delonghi.com website.



To use the filter correctly, follow the instructions below.

1. Remove the filter (D4) from the pack and turn the date indicator so that it shows the next 2 months (fig. 7);

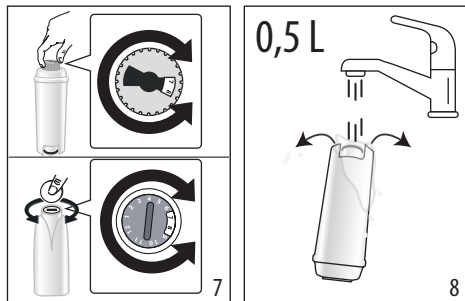

- To activate the filter, run drinking water through the hole in the centre of the filter until water comes out of the openings at the side for more than a minute (fig. 8);
- Remove the tank (A9) from the machine (fig. 4) and fill with fresh drinking water; insert the filter in the water tank, immersing it completely for about ten seconds, while tilting it and applying light pressure so that the air bubbles are able to escape (fig. 9);

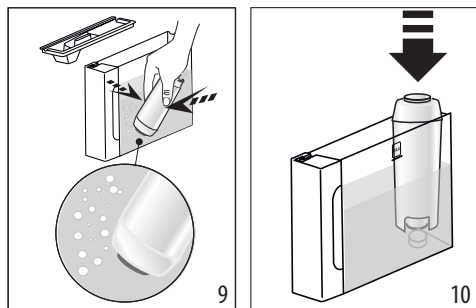

- Insert the filter in the relative housing and press fully home (fig. 10);
- Close the tank with the lid (A8), then reposition the tank in the machine;
- If not already in place, fit the water spout (D5).
- Place an empty container of at least 0.5 litres capacity under the hot water spout (fig. 5).
- See instructions in section "12. Settings menu" for installation of the filter;
- On the control panel, the filter indicator light (C1) blinks steadily and the Led of the clean carafe/manual rinse button (B4) blinks rapidly;
- Press the clean carafe/manual rinse button (fig. 11);

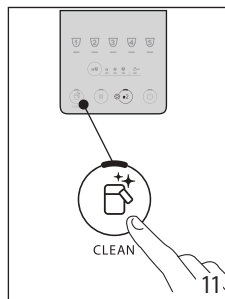

- The appliance delivers hot water, stopping automatically;
- When the flow stops, the filter indicator light extinguishes: the filter is now active and the machine can be used.

Please note:

- If the Led of the  button (B4) blinks rapidly, press the button. This will cause the internal circuits of the machine to start filling up, expelling the air bubbles that have been formed and allowing the installation to proceed.
- With installation completed, the drinks Leds blink to indicate that the machine is heating up in readiness for normal use.

4.1 Replacing the filter

Replace the filter (D4) when the  indicator (C1) lights up.

- Remove the water tank (A9) and the spent filter;
- Follow the operations described in the previous section to activate the filter;
- See instructions in section "12. Settings menu" to set the machine and repeat steps 9 to 12 of the preceding section.

Please note:

After two months (see date indicator), or after 3 weeks if the appliance has not been used, the filter should be replaced even if the warning message has not yet been displayed.

4.2 Removing the filter

If the intention is to use the appliance without the filter (D4), its removal must be indicated in the machine settings.

- Remove the water tank (A9) and the spent filter;
- See instructions in section "12. Settings menu" to set the machine accordingly.

Please note:

After two months (see date indicator), or after 3 weeks if the appliance has not been used, the filter should be replaced even if the warning message has not yet been displayed.

5. MEASURING WATER HARDNESS

Setting the water hardness as soon as possible will enable the machine to optimize the frequency of descaling. This means that the descale indicator  (C5) will light up as necessary

according to the actual hardness of the local water supply. Proceed as follows:

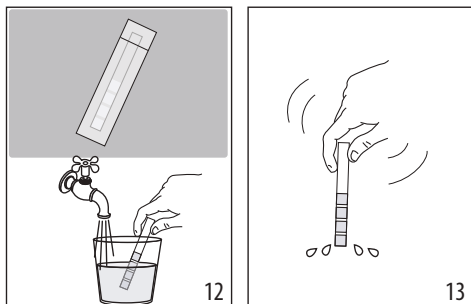

1. If a total hardness test strip (D1) is supplied with the model of machine in question, remove it from its wrapper.
2. Immerse the strip completely in a glass of water for about one second (fig. 12).
3. Remove the strip from the water and shake lightly (fig. 13). After about a minute, 1, 2, 3, or 4 red squares appear, depending on the hardness of the water. Each square corresponds to one level.

Total Hardness Test	Hardness
	1 Low
	2 Medium
	3 Medium/High
	4 High

See instructions in section “12. Settings menu” to set the machine accordingly.

6. TURNING THE MACHINE ON

Danger of scalding!

During the rinse, a little hot water flows from the coffee spouts (A16). Take care to avoid contact with splashes of water. To avoid the need for frequent emptying of the drip tray (A14), place a container under the spouts to collect the rinse water.

- To switch on the machine, press the button (B1): the Led of the on/off button lights up and the drinks Leds blink on the control panel (B) to indicate that the machine is warming up.

During this step, the machine performs a rinse cycle. Besides heating up the boiler, this also serves to circulate hot water through the internal circuits so they too are brought up to temperature.

The appliance is ready for use when the drinks and intensity Leds remain permanently alight.

7. TURNING THE MACHINE OFF

Whenever the machine is turned off after being used to make coffee, it performs an automatic rinse cycle.

Danger of scalding!

During the rinse, a little hot water flows from the coffee spouts (A16). Take care to avoid contact with splashes of water. To avoid the need for frequent emptying of the drip tray (A14), place a container under the spouts to collect the rinse water.

- To switch the machine off, press the button (B1);
- the drinks indicator Leds on the control panel will now blink: the appliance performs a rinse cycle, if envisaged, and then switches off (stand-by).

7.1 Switching off for extended periods:

If the machine is not going to be used for any length of time (e.g. holidays, periods of absence), proceed as follows:

- turn off the machine by pressing the button (B1);
- empty out and clean the grounds container (A10) and the water tank (A9);
- unplug the power cord (A7) from the socket.

Please note:

When turning the machine on again, fill the water tank and, before making any kind of drink, run 3 rinse cycles as indicated in section “8.6 Rinsing”.

8. MAKING COFFEE DRINKS

8.1 Making coffee using coffee beans



Important!

Do not use green, caramelized or candied coffee beans as they could stick to the coffee mill and make it unusable.

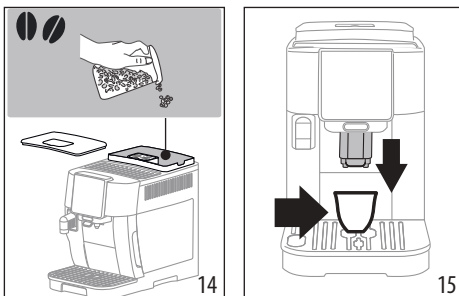
1. Fill the container (A3) with coffee beans (fig. 14);





2. Place a cup under the coffee spouts (A16) (fig. 15);
3. Lower the spouts as near as possible to the cup: this makes a creamier coffee (fig. 15);
4. Select the required drink:

Drink (*)	Default quantity (ml)	Programmable quantity (ml)
 Espresso	40	from ≈ 20 to ≈ 180
 Coffee	180	from ≈ 100 to ≈ 240
 Doppio+	120	from ≈ 80 to ≈ 180

(*) Numbers and types of drinks differ according to model.

- Preparation begins and the Led corresponding to the selection blinks on the control panel (B).

8.2 Making 2 cups of coffee

- Place the cups under the coffee spouts (A16);
- Lower the spouts as near as possible to the cups: this makes a creamier coffee;
- Press the  button (B2): the corresponding Led lights up;
- Press the  button (B8);
- Preparation begins and the Led corresponding to the Espresso button blinks on the control panel (B).

8.3 Making coffee using pre-ground coffee

Important!

- Never add pre-ground coffee when the machine is off, or it could spread through and soil the inside of the machine. This could cause damage to the machine.
- Never use more than 1 level measure (D2), as this could soil the inside of the machine or block the funnel (A4).



Please note:

When using pre-ground coffee, only one cup can be made at a time.

- Press the  button (B5) repeatedly until the Led lights up (B7).
- Make sure the funnel is not blocked, then add one level measure of pre-ground coffee (fig. 16).

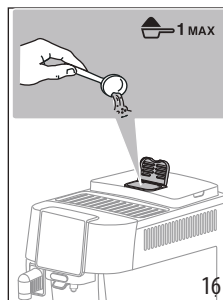

- Place a cup under the coffee spouts (A16) (fig. 15);
- Select the required drink (B8);
- Preparation begins and the Led corresponding to the selection blinks on the control panel (B).

Important!

- It is not possible to make a  Doppio+ coffee using pre-ground coffee.

8.4 General indications for making coffee-based drinks













- Indicator lights may appear on the control panel (B) during use. Their meaning is given in section "17. Explanation of lights".
- To make a hotter coffee, see section "8.7 Tips for a hotter coffee".
- If the coffee is delivered a drop at a time, too weak and not creamy enough or too cold, read the tips in section "18. Troubleshooting".
- To customize drinks according to personal taste, see sections "8.5 Varying the intensity of the coffee" and "8.9 Customizing the quantity in the cup".

Please note:

In energy saving mode, a few seconds may elapse before the first coffee is delivered as the machine must heat up again.

8.5 Varying the intensity of the coffee

- Press the  button (B5) repeatedly until the Leds relative to the desired intensity light up (B6):

	  	
  		Mild
  		Medium
  		Strong

- Select the desired coffee drink.

Please note:

- When the next coffee is made, the machine will show the last intensity setting selected.
- In the event of power failure, the machine will revert to the default setting: medium.

8.6 Rinsing

Using this function, hot water can be delivered from the coffee spouts to clean and heat the internal circuit of the machine.

- Place a container of at least 100ml capacity under the coffee spouts (A16) (fig. 5).
- Press the  button (B4) and hold for at least 5 seconds: the cycle will start and stop automatically (to terminate the cycle sooner, press this same button a second time).

Please note:

- If the machine is not used for more than 3-4 days it is highly advisable, when switching on again, to run 2/3 rinse cycles before preparing any drinks;
- It is normal for the grounds container (A10) to contain water following a rinse cycle.

8.7 Tips for a hotter coffee

To make a hotter coffee, proceed as follows:

- run a rinse cycle (see section “8.6 Rinsing”);
- warm the cups using the Hot water function;
- set a higher coffee temperature via the menu (see section “12. Settings menu”).

8.8 Adjusting the coffee mill

The coffee mill does not require any adjustment, at least initially, as it has been factory set to ensure that coffee is prepared correctly.

Please note:

The adjustment dial must be turned only when the coffee mill is in operation during the initial step of coffee preparation.

To make an adjustment while the coffee mill is in operation, turn the dial (A2) as follows:

<p>If the coffee is delivered too slowly, or not at all.</p> <p>The effect of this adjustment will not be noticeable until at least 2 further coffees have been made.</p>	<p>Turn one click toward number “7”</p> 
---	---

<p>For a fuller bodied and creamier coffee</p> <p>The effect of this adjustment will not be noticeable until at least 2 further coffees have been made.</p>	<p>Turn one click toward number “1”</p> 
---	--

Please note:

- To interrupt delivery, press any drink selection button.
- At the end of delivery, to increase the quantity of coffee in the cup, simply press and hold the drink selection button (within 3 seconds); the Led will blink rapidly.

8.9 Customizing the quantity in the cup

- Press the button relative to the drink being programmed and hold for a few seconds: when the Led corresponding to the selection blinks rapidly, the machine is in programming mode. Delivery begins;
- Once the cup is filled to the desired level, press the button again: delivery ceases and the quantity is stored.

Please note:

To cancel the current setting, press a button corresponding to another drink.

9. MAKING MILK-BASED DRINKS

Please note:

- Before using the carafe, check that all the components are cleaned and assembled as described in section “14. Thorough cleaning of milk carafe”
- To ensure that milk is not under-frothed or topped with large bubbles, always clean the milk container lid (E1) and the carafe connector (E6) as described in sections “9.6 Cleaning the milk carafe after each use”, and “14. Thorough cleaning of milk carafe”.

9.1 What milk to use?

The quality of the froth will vary depending on:

- the temperature of the milk or vegetable drink used (for best results, always use milk or vegetable drink straight from the fridge, 5 °C);
- type of milk or vegetable drink;
- the brand used;
- ingredients and nutritional values.

<p>Cow's milk</p>	<p>LatteCrema HOT </p>
	<p style="text-align: right;">→</p>

LatteCrema HOT	
Whole (fat >3,5%)	✓
Semi-skimmed (fat between 1.5 and 1.8%)	
Skimmed (fat <0.5%)	
Vegetable drinks	
Soya	✓
Almond	✓
Oatmeal	✓

Please note:

For best results when using vegetable drinks, select “Barista” versions of these products to optimize the quality of the froth.

9.2 How much milk?

The milk container (E7) is marked with a graduated scale (fig. 17) to help ensure that the ideal quantity of milk will be poured when preparing the drink.

The intermediate marks correspond to increments of ≈ 20 ml.

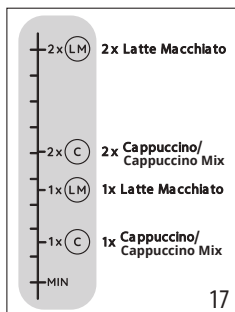

Please note:

- Depending on the type and temperature of the milk used, the recipe can differ slightly from one drink to another.
- If there is insufficient milk in the carafe, the milk spout will produce a dry puff.

9.3 Filling and attaching the milk carafe

1. Release the lid (E1) by turning clockwise: the reference mark on the lid must be aligned with the symbol (fig. 18);
2. Then lift the lid (fig. 19)

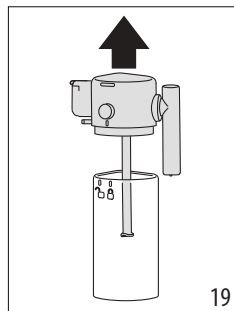
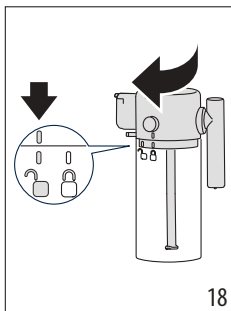

3. Fill the milk container (E7) with suitable quantity of milk (fig. 17 and 20);
4. Make sure the milk intake tube (E4) is secured correctly to the socket on the underside of the milk carafe lid (fig. 21);

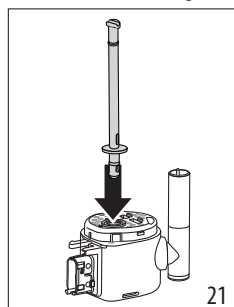
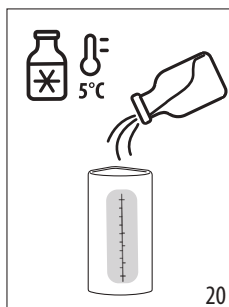

5. Close the carafe: refit the lid (the reference mark on the lid must be aligned with the symbol) then turn toward the symbol until locked in position (fig. 22);
6. Lower the flap and attach the carafe to the connector, pushing it fully home (fig. 23). The machine emits a beep (if the beep function is enabled).

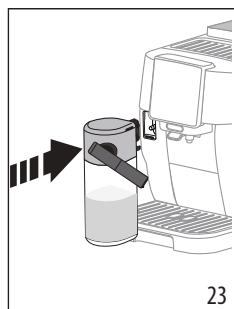
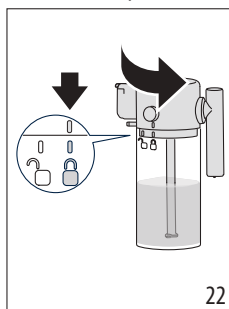

9.4 Selection of coffee intensity or use of pre-ground coffee

Once the milk carafe has been prepared, before selecting the desired milk-based drink, the intensity of the coffee can be customized as described in section “8.5 Varying the intensity

of the coffee” or alternatively, select pre-ground coffee (and in this instance, proceed to add one measure of coffee as indicated in section “8.3 Making coffee using pre-ground coffee”).

9.5 Delivering milk-based drinks

1. Place a cup of suitable size under the coffee spouts (A16) and under the frothed milk spout (E3) (fig. 24).
2. Select the milk-based drink from the control panel

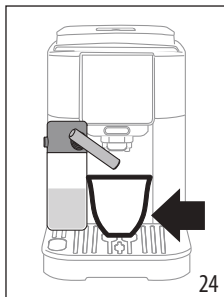



Please note:

If “Energy Saving” mode is activated (see section “12. Settings menu”), there may be a few seconds delay before the drink is delivered.

9.6 Cleaning the milk carafe after each use

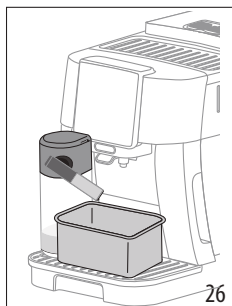
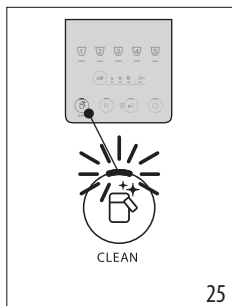
Following each delivery of a milk-based drink, the Led associated with the  button will blink on the control panel (B4) (fig. 25).



1. Leave the milk carafe in the machine (there is no need to empty the milk container);
2. Place a cup or other recipient under the milk spout (fig. 26);
3. Press the  button: hot water and steam will be released from the milk spout. Cleaning stops automatically;
4. Press the release button (E5) on the lid (E1) and pull the carafe to remove it (fig. 27).

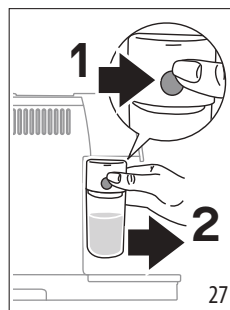

Where various drinks are prepared in succession:

- Proceed with cleaning of the carafe after the final preparation.

After multiple preparations, the milk carafe is empty or the milk that remains is not enough to make further drinks

- Having carried out the cleaning step with the  button, disassemble the milk carafe and clean all components, proceeding as described in the section “14. Thorough cleaning of milk carafe”.

After multiple preparations, there is enough milk left in the carafe to make further drinks

- Having carried out the cleaning step with the  button, remove the milk carafe and put it straight in the refrigerator. The carafe still containing milk can be kept in the refrigerator for no more than 2 days, after which time all components should be cleaned, proceeding as described in the section “14. Thorough cleaning of milk carafe”.

Important:

If the milk carafe is left out of the refrigerator for more than **30 minutes**, disassemble and clean all components, proceeding as described in the section “14. Thorough cleaning of milk carafe”.

Following preparation of milk-based drinks — general notes:

- In certain cases, the machine will need to heat up before cleaning can take place.
- Wait for cleaning to be completed. The function ceases automatically, it must not be stopped while in progress.

9.7 Customizing the quantity in the cup

1. Press the button relative to the milk-based drink being programmed, and hold for a few seconds. The light blinks rapidly to indicate that the programming menu is active. Delivery of the first ingredient will start;

- Once the cup is filled to the desired level, press the drink button a second time: delivery of the first ingredient stops and delivery of the second ingredient begins;
- Once the cup is filled to the desired level, press the button again: delivery ceases and the quantity is stored.

Please note!

- To cancel the current setting, press a button corresponding to another drink.

10. DELIVERING HOT WATER

Danger of scalding!

Never leave the machine unattended when hot water is being released.

- Lower the flap and fit the hot water spout (fig. 28).

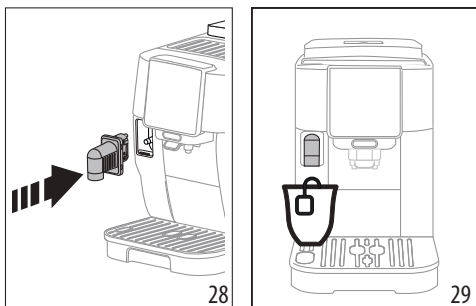

- Place a container under the hot water spout (fig. 29) as close as possible to avoid splashes).
- Press the Hot water button .

- Delivery will stop automatically. To terminate the delivery sooner, press the  button a second time.

Please note:

In energy saving mode, a few seconds may elapse before hot water emerges as the machine must heat up.

10.1 Customizing the quantity of hot water

- Press the Hot water button  and hold for a few seconds: the light blinks rapidly to indicate that the programming menu is active. Delivery begins;
- Once the cup is filled to the desired level, press the button again: delivery ceases and the quantity is stored.

	Default (ml)	Programmable (ml)
 Hot water	250	from ≈ 20 to ≈ 420

Please note!

To cancel the current setting, press a button corresponding to any drink

11. TIPS FOR ENERGY SAVING

- To reduce energy consumption, remove the milk carafe after one or more drinks have been delivered;
- Set auto-off to 15 minutes (see “12. Settings menu”);
- Enable Energy Saving (see “12. Settings menu”);
- Always carry out the descaling cycle when prompted by the machine.

12. SETTINGS MENU

Having accessed the menu, the buttons that remain active can be used to select the corresponding functions:

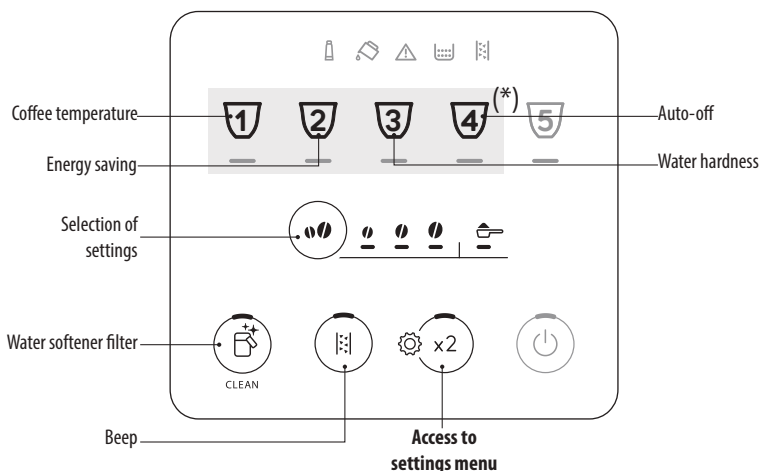

(*) Drinks differing according to model

1. Access the menu:

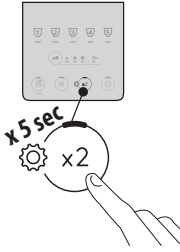

Press and hold the  x2 button for a few seconds: the buttons used for selecting settings will light up. Proceed by pressing the button for the setting to be changed.

2. Change the machine settings:

Water softener filter



Press the intensity button repeatedly until the Leds relative to the desired setting light up

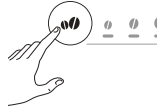

FILTER IN PLACE



(Ref: "4. Water softener filter" and "4.1 Replacing the filter")

FILTER REMOVED



(Ref: "4.2 Removing the filter")

Confirm selection

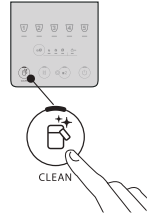

Beep

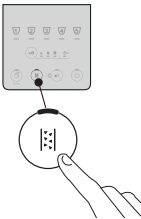

Press the intensity button repeatedly until the Leds relative to the desired setting light up



ENABLED



DISABLED



Confirm selection

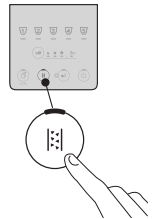

Coffee temperature

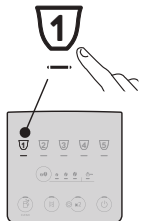

Press the intensity button repeatedly until the Leds relative to the desired setting light up



LOW



MEDIUM









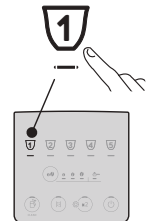





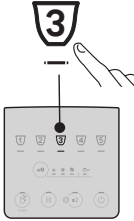



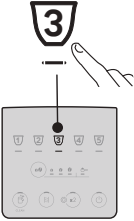
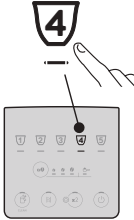

HIGH



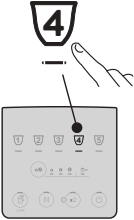
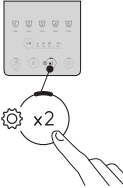

Confirm selection

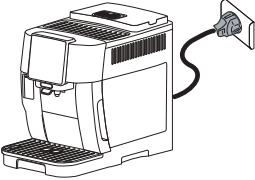

<p>Energy saving</p> 	<p>Press the intensity button repeatedly until the Leds relative to the desired setting light up</p> 	<p>ENABLED</p>  <p>DISABLED</p> 	<p>Confirm selection</p> 
<p>Water hardness</p> 	<p>Press the intensity button repeatedly until the Led corresponding to the required level lights up</p> 	<p>LEVEL 1</p>  <p>LEVEL 2</p>  <p>LEVEL 3</p>  <p>LEVEL 4</p> 	<p>Confirm selection</p> 
<p>Auto-off</p> 	<p>Press the intensity button repeatedly until the Led corresponding to the required time setting lights up</p> 	<p>15 MINUTES</p>  <p>30 MINUTES</p>  <p>1 HOUR</p>  <p>3 HOURS</p> 	<p>Confirm selection</p> 
<p>3. Exit the menu:</p>			
	<p>Press the  button: The machine is ready for use again.</p> <p>Please note! After 30 seconds without a button being pressed, the machine exits the settings menu automatically.</p>		

12.1 Restore factory settings

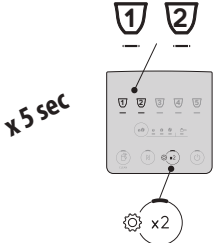
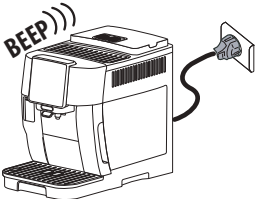



<p>Make sure the machine is in stand-by (off, but connected to the mains power supply).</p>	
<p>Press the drinks buttons 1, 2 and  x2 hold for 5 seconds: all settings and drink quantities will be reset to the default factory values.</p>	
<p>The machine emits a long beep and all indicator lights blink to confirm the reset</p>	



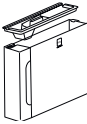
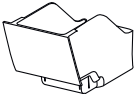

13. CLEANING THE MACHINE

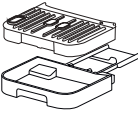
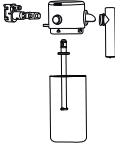
Important!

- Do not use solvents, abrasive detergents or alcohol to clean the machine. With De'Longhi superautomatic coffee machines, no chemical additives are required for cleaning purposes.
- Do not use metal objects to remove encrustations or coffee deposits as they could scratch metal or plastic surfaces.

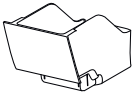

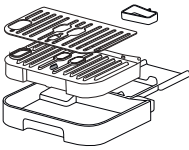
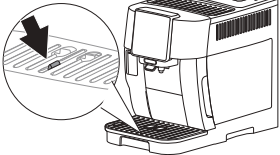
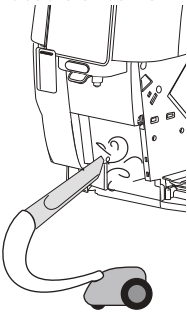
					
 50°C	✗	✗	✗	✓	✓
	✓	✓	✓	✓	✓

Component	Frequency	Procedure
<p>Grounds container</p> 	<p>When the  indicator lights up, the grounds container must be emptied: the machine cannot now make coffee.</p> <p>The appliance cannot be used to make coffee again until the grounds container has been cleaned. The machine will display the message indicating the need to empty the grounds container 72 hours after the first coffee has been prepared, even if the container is not full (for the 72 hours to be calculated correctly, the machine must never be disconnected from the mains power supply).</p>	<ul style="list-style-type: none"> Remove the drip tray, empty and clean. Empty the grounds container and clean thoroughly to remove all residues that may have collected on the bottom. Check the condensate tray (colour red) and if full, empty if out.
<p>Drip tray components</p> 	<p>The drip tray is fitted with a level indicator (colour red) showing the level of water it contains.</p> <p>Before the indicator projects from the cup tray, the drip tray must be emptied and cleaned</p> 	<ul style="list-style-type: none"> Remove the drip tray and the grounds container; Remove the cup tray and drip tray grille, then empty the drip tray and the grounds container and wash all components; Check the red condensate tray and, if full, empty if out; Reposition the drip tray complete with grille, and the grounds container. <p>When removing the drip tray, the grounds container must also be emptied, even if it is not completely full.</p>
<p>Inside of the machine</p> 	<p>Check periodically (about once a month) that the inside of the machine (accessible by removing the drip tray) is not dirty.</p>	<p>Switch the machine off and isolate it from the power supply. Never immerse the machine in water.</p> <ul style="list-style-type: none"> Remove coffee deposits with a brush and sponge; Remove all residues with a vacuum cleaner
<p>Coffee spouts</p> 	<p>Clean the coffee spouts periodically (once a month)</p>	<ul style="list-style-type: none"> Clean the coffee spouts periodically with a sponge or cloth; Check that the holes in the coffee spout are not blocked. If necessary, remove coffee deposits with a toothpick.

14. THOROUGH CLEANING OF MILK CARAFE

VERY IMPORTANT

To ensure optimum results are obtained from the Lattecrema system over time, clean the milk carafe thoroughly on a regular basis.

Clean the milk carafe as described below:

1. Release the lid (E1) by turning clockwise: the reference mark on the lid must be aligned with the  symbol (fig. 18);
2. Now lift the lid (fig. 19).
3. Pull out the milk intake tube (30);

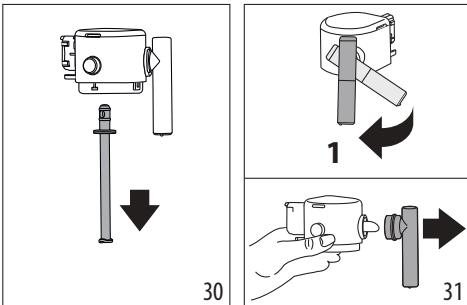

4. Turn the milk spout at right angles to the body and pull until completely detached (fig. 31);
5. Press the button (E5) to separate the connector (fig. 32).

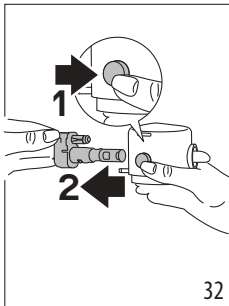

6. Wash in a dishwasher (recommended) or by hand as indicated below:
 - **In a dishwasher:** Rinse all the above components and the milk container under hot running drinking water (at least 40 °C), then place them in the top basket of the dishwasher and run a wash programme at 50 °C, e.g. standard ECO.
 - **By hand:** Rinse all the components and the milk container thoroughly with hot running drinking water (at least 40 °C) to remove all visible milk residues, making certain to direct the water through all the holes of the lid (fig. 33). Next,

immerse all the components in a solution of hot drinking water (at least 40° C) and washing up liquid for at least 30 minutes. Rinse all the components described above thoroughly under hot drinking water, rubbing each one individually between fingers and thumbs.

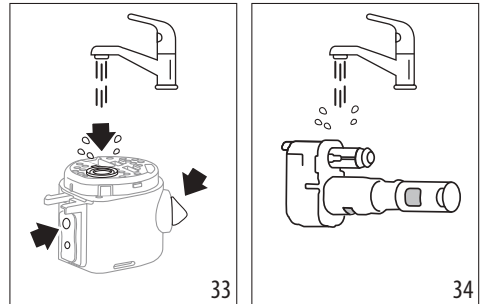

7. Rinse the milk carafe connector (E6) thoroughly (fig. 34). Take particular care to ensure that there are no milk residues in the air channel (see enlargement) (fig. 35): free the channel clean if need be, using a toothpick;

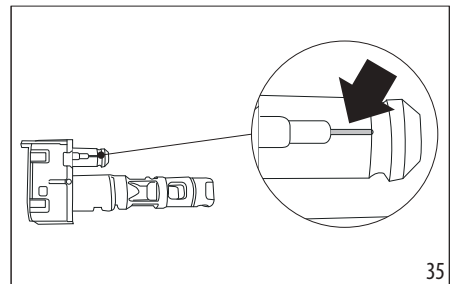

8. Dry all the components with a clean dry cloth;
9. Push the connector fully home (fig. 36 and 37): when securely inserted, the connector can be detached only by pressing the release button on the lid.

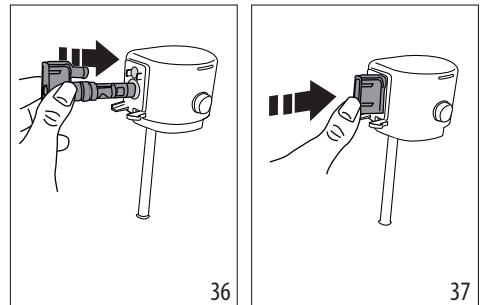

10. Reassemble all the lid components;
11. Close the carafe: refit the lid (the reference mark on the lid must be aligned with the  symbol marked on the

milk container (E7) then turn toward the  symbol until locked (fig. 22).

15. CLEANING THE INFUSER

Clean the infuser (A6) regularly, at least once a month.

Important!

The infuser (A6) cannot be removed while the machine is on.

1. Press the  button (B1) to turn the machine off;
2. Remove the water tank (A9);
3. Open the infuser flap, positioned on the right hand side (fig. 38);
4. Press the two coloured release buttons inwards (fig. 39), at the same time pulling the infuser outwards;

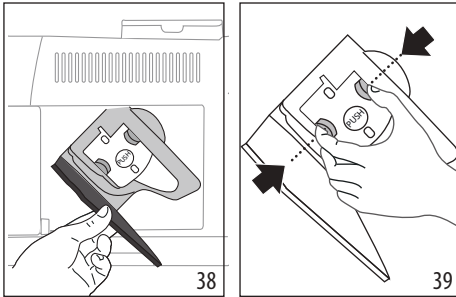

5. Immerse the infuser in water for about 5 minutes, then rinse under the tap;

Important!

RINSE WITH WATER ONLY

NO DETERGENTS - NO DISHWASHER

6. Do not use detergents when cleaning the infuser, as they could damage it.
7. Use a brush to remove any coffee residues left in the infuser housing, which can be seen through the infuser flap;
8. After cleaning, replace the infuser by sliding it into its housing, then apply pressure to the PUSH symbol until it clicks into place;

Please note:

If the infuser proves difficult to insert, adapt it (before insertion) to the right position by pressing the two levers (fig. 40).

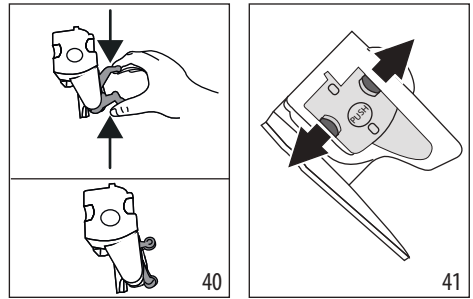

9. Once inserted, make sure the two coloured buttons have snapped out (fig. 41);
10. Close the infuser flap;
11. Reposition the water tank in the machine.

16. DESCALING

- Before use, read the instructions and the labelling on the descaler pack.
- Use only descaler supplied by De'Longhi. Using unsuitable descaler and/or performing descaling incorrectly may result in faults not covered by the manufacturer's guarantee.
- Descaler can cause damage to delicate surfaces. If the product is accidentally spilt, dry immediately.

To descale

Descaler	De'Longhi descaler
Container	Recommended capacity: 2l
Time	~30min
Accessory	Hot water spout (D5)

Important:

If the water softener filter is installed, it must be removed before adding the descaler solution. Thereafter, reinstate the filter at the start of step 3

Descalce the machine when the  indicator lights up on the control panel (C4). This same indicator will blink while the descale cycle is in progress.

Please note:

- Once the descaling cycle has begun, it cannot be interrupted and must be concluded with the full rinse cycle. With this in mind, make sure there is sufficient descaler.

Proceed as follows:

1. Make certain that the water spout (D5) is fitted;

Step 1: Descaling action	
---------------------------------	--

- Press the button (B5) and hold for at least 5 seconds, until the relative Led starts blinking rapidly. The indicator Led (C5) blinks to confirm that the descaling programme is in progress. The mild intensity Led lights up to indicate that step 1 of the descale cycle is in progress;
- Empty the drip tray (A14) and the grounds container (A10) and reposition them; empty the water tank completely (A9) and remove the softener filter (if installed);
- Pour the descaler into the water tank up to level **A** (corresponding to a 100 ml pack) marked on the inner surface of the tank (fig. 42), then add water (1 litre) up to level **B** (fig. 43) and reposition the water tank in the machine.

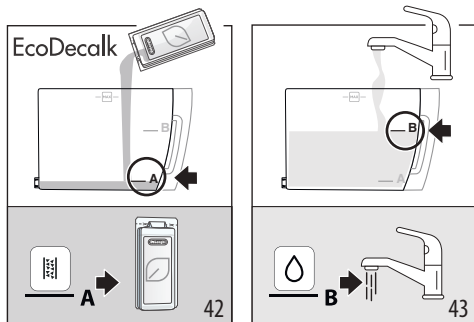

- Place an empty container of at least 2 litres capacity under the coffee spouts (A16) and the water spout (D5) (fig. 44).

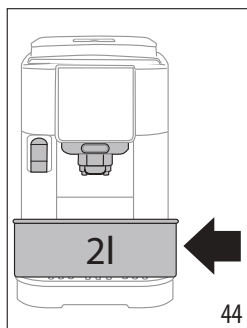

- Press the button to start the descaling cycle; the indicator light blinks to confirm that step 1 is in progress;
- For 15 minutes or so, the machine alternates automatically between pausing and releasing liquid from the hot water spout and the coffee spout.

When the first step of the descaling cycle has been completed, the low water level indicator (C2) will light up.

Step 2: First rinse	
----------------------------	--

- Empty the container used to collect the descaler solution. Remove and empty the water tank, rinse under running water, then fill with fresh drinking water up to the MAX level (fig. 45) and return it to the machine: reposition the container under the spouts;

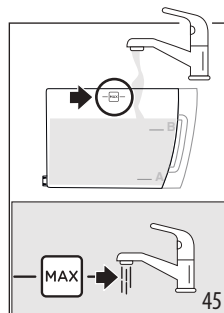

- Press the button (which blinks rapidly) to start the rinse: the medium intensity Led blinks to indicate that step 2 of the descale cycle is in progress;
 - The machine will proceed automatically with rinsing of the coffee and hot water spouts;
- When the second step of the descaling cycle has been completed, the low water level indicator (C2) will light up.

Step 3: Second rinse	
-----------------------------	--

- Empty the container used to collect the water from the first rinse. Remove and empty the water tank, then fill with fresh drinking water up to the MAX level (fig. 44) and reinstate the softener filter, if in use; return the tank to the machine and reposition the container under the spouts;
- Press the button (which blinks rapidly) to start the rinse: the strong intensity Led blinks to indicate that step 3 of the descale cycle is in progress; the rinse fluid will flow from the hot water spout; (*)

Step 4: Completion of descale procedure	
--	--

- When the Led relative to the pre-ground function lights up, the descale cycle has been correctly terminated;
- The indicator of the grounds container (C4) lights up: remove the container in which the rinse water is collected and empty it; take out the drip tray and empty the grounds container, where part of the rinse water will have been collected. Reposition all the parts in the machine.



15. The “no water” indicator (C2)lights up: remove the tank and fill with fresh drinking water. Reposition the water tank in the machine.





The machine is ready for use.

Please note:

- It is normal for the grounds container to contain water following a rinse cycle.
- (*) If the water tank has not been filled to the MAX level, at the end of descaling, the system requests a third rinse to guarantee that the descaler solution has been completely eliminated from the machine's internal circuits. In this instance, repeat step 3 from point 11.

17. EXPLANATION OF LIGHTS

Indicator/Led	Meaning
Drink indicators blinking	The machine is warming up: wait
Drink and settings indicators permanently alight	The machine is ready for use: select the desired drink and the relative options
	Replace the filter (see section “4. Water softener filter”)
	Insufficient water in tank: fill the tank
	The water tank is missing, or is not positioned correctly: ensure the tank is correctly in place
	→

Indicator/Led	Meaning
	General alarm: the inside of the machine is very dirty. Clean the machine thoroughly. If the message is still displayed after cleaning, contact De’Longhi Customer Services and/or an approved Service Centre
	The infuser has not been replaced after cleaning: reinstate the infuser as described in section “15. Cleaning the infuser”
	No coffee beans: fill the beans container, then press any button to exit the alarm condition.
	The beans are too finely ground, so that the coffee is delivered too slowly or not at all. Adjust the coffee mill (A2) (section “8.8 Adjusting the coffee mill”).
	A selection has been made using pre-ground coffee without putting the coffee in the relative funnel (A4)
	→

Indicator/Led	Meaning
	<p>Too much coffee has been used. Select a milder intensity or reduce the quantity of pre-ground coffee</p>
	<p>The coffee emerges too slowly or drop-by-drop.. The coffee is ground too finely. Use coffee for espresso machines.</p>
	<ul style="list-style-type: none"> • A milk drink has been selected, but the connector (E6) has not been properly inserted: check that the milk carafe is complete with all components correctly assembled (see section "14. Thorough cleaning of milk carafe") • The milk carafe was removed during delivery of milk. Reposition the milk carafe: the machine is ready for use again • A milk drink has been requested, but there is not enough milk in the container (see section "9.2 How much milk?").
→	

Indicator/Led	Meaning
	<p>Hot water has been selected, but the spout is not in place: fit the water spout</p>
	<p>The water circuit is empty. Deliver hot water by pressing the corresponding button Hot Water</p>
	<p>The grounds container needs emptying (A10)</p>
	<p>The grounds container (A10) is missing, or not inserted correctly: insert the drip tray complete with the grounds container and press fully home</p>
	<p>Descaling is required ("16. Descaling ")</p>
→	

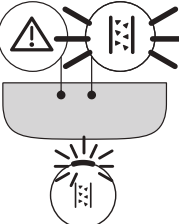
Indicator/Led	Meaning
	Descaling has been interrupted. Complete the cycle, restarting from the step indicated by the intensity selection Leds.
→	

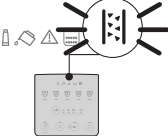
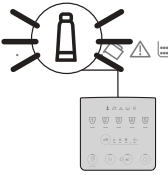
Indicator/Led	Meaning
	Descaling in progress
	Installation/Replacement of water filter softener progress

18. TROUBLESHOOTING

Possible malfunctions of the machine are listed below.

If the problem cannot be resolved as described, contact Customer Service.

Problem	Cause	Solution
The appliance does not switch on.	The cord is not plugged into the mains socket.	Plug into the mains socket.
The coffee is not hot.	The cups were not preheated.	Warm the cups by rinsing them with hot water (Please note: the hot water function can be used).
	The internal circuits of the appliance have cooled down because 2-3 minutes have elapsed since the last coffee was made.	Before making coffee, warm the internal circuits by pressing and holding the  button (B4) for a few seconds to run a rinse cycle.
	Coffee temperature setting too low.	Select a hotter coffee temperature in the settings menu (see "12. Settings menu").
	The machine needs descaling	Run the descale procedure. Next, check the water hardness ("5. Measuring water hardness") and make sure the machine setting matches the local water supply hardness ("12. Settings menu").
The coffee is weak or not creamy enough.	Coffee ground too coarsely.	Adjust the grinding level ("8.8 Adjusting the coffee mill"). The effect will not be noticeable until at least 2 coffees have been made.
	Coffee not suitable.	Use coffee for espresso machines.
	Coffee not fresh.	The coffee pack has been opened for too long and has lost its taste.
→		

Problem	Cause	Solution
The coffee emerges too slowly or drop-by-drop.	Coffee ground too finely.	Adjust the grinding level ("8.8 Adjusting the coffee mill"). The effect will not be noticeable until at least 2 coffees have been made.
The machine does not deliver coffee.	Impurities have been detected in the internal circuits	Wait until the machine is ready for use again, and proceed to select the required drink. Contact an authorized Service Centre if the problem persists.
Coffee does not come out of one or both spouts.	Coffee nozzles blocked.	Clean the nozzles with a cloth. Any encrusted deposits can be removed with a toothpick, if necessary.
The coffee delivered is watery.	Pre-ground coffee funnel clogged.	Open the flap and clean the funnel with the aid of a brush.
The infuser cannot be removed.	The machine has not been correctly switched off.	Switch the machine off by pressing the  button.
With the descaling procedure completed, the appliance prompts for a third rinse	During the two rinse cycles, the water tank was not filled to the MAX level	Restart the descaling procedure from "Step 3: Second rinse".
The milk presents large bubbles, or splashes from the spout(E3) , or is under-frothed.	Milk is not cold enough, or is not semi-skimmed or skimmed.	Use skimmed or semi-skimmed milk straight from the refrigerator (temperature about 5° C). If the result is still not as expected, try changing the brand of milk.
	Milk carafe lid dirty.	Disassemble the components and clean thoroughly as described in section "9.6 Cleaning the milk carafe after each use". Take particular care when cleaning the milk carafe connector (E6).
	Vegetable drinks are being used.	The end-result varies widely depending on the nutritional properties of the drinks. "Barista" versions of these drinks are recommended.
Milk-based drinks are not enabled	Milk carafe missing or not correctly in place.	Prepare the milk carafe and position it correctly in the machine.
	Several milk drinks have been prepared in succession and the machine needs to heat up to the right temperature in order to make the next drinks.	Wait until milk-based drinks are again enabled on the control panel.
The cup tray on top of the machine is hot	Several drinks have been prepared in rapid succession	
The machine emits noises or small puffs of steam while not in use	The machine is ready for use or has just been turned off, and a few drops of condensate are falling into the steamer, which is still hot.	This is to be expected as an aspect of normal operation: to minimize the effect, empty the drip tray regularly.
→		

Problem	Cause	Solution
The machine emits puffs of steam from the drip tray and/or there is water on the surface where the machine is positioned.	The drip tray grille has not been replaced after cleaning.	Ensure the grille is repositioned in the drip tray.

19. TECHNICAL DATA

Voltage:	220-240 V~ 50-60 Hz max. 10 A
Power:	1450 W
Pressure:	1.5 MPa (15 bars)
Water tank capacity:	1.8l
Size LxDxH:	240x440x350 mm
Cord length:	1250 mm
Weight (varies according to model):	8.8 kg
Beans container capacity:	250 g

De'Longhi reserves the right to modify the technical specification and styling of its products at any moment, without compromising their functionality and quality.

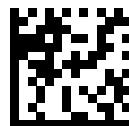

57132C8477_00_0623